

EVI DC Inverter Heat Pump (with WIFI APP)

OPERATING INSTRUCTION MANUAL

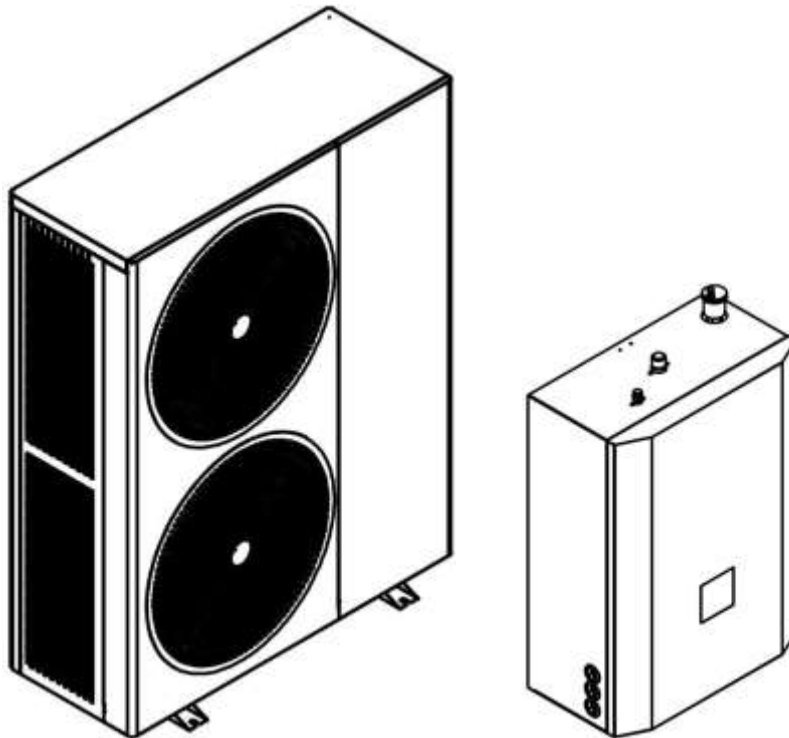

IMPORTANT SAFETY INSTRUCTIONS
READ AND FOLLOW ALL INSTRUCTIONS
SAVE THESE INSTRUCTIONS

Table of Contents

IMPORTANT SAFETY PRECAUTIONS	3	
Section 1	Introduction.....	4
Product Overview		4
General Features		4
Section 2	Installation	5
Materials Needed for Installation.....		5
Installation Location.....		7
Installation Details.....		7
Drainage and Condensation		8
Suggested Installation Methods		8
Water Connections.....		12
Plumbing Installation Requirements.....		12
Electrical Connections		13
Power Supply.....		13
Grounding and Over Current Protection.....		13
Electrical Wiring Diagram		14
Section 3	Operating Heat Pump	15
Controller Panel.....		15
1. Display Icon.....		15
2. Definition of Buttons		16
3. Wire Controller Operation		17
General Operating Guide		24
Users' Guide		24
Section 4	General maintenance.....	25
Controller Error Codes.....		25
Owner Inspection		27
Troubleshooting		28
Section 5	WIFI Connection and Operation.....	31
APP Download.....		31
WIFI Connect Method 1: intelligent network distribution mode		31
WIFI Connect Method 2:AP distribution network mode.....		35
Software function operation		38

IMPORTANT SAFETY PRECAUTIONS

Important Notice:

This guide provides installation and operation instructions for the EVI DC Inverter Air Source Heat Pump. Consult the seller with any questions regarding this equipment.

Attention Installer: This guide contains important information about the installation, operation and safe use of this product. This information should be given to the owner and/or operator of this equipment after installation or left on or near the heat pump.

Attention User: This manual contains important information that will help you in operating and maintaining this heat pump. Please retain it for future reference.



WARNING - Before installing this product, read and follow all warning notices and instructions which are included. Failure to follow safety warnings and instructions can result in severe injury, death, or property damage.

Codes and Standards

The EVI DC Inverter Air Source Heat Pump must be installed in accordance with the local building and installation codes as per the utility or authority having jurisdiction. All local codes take precedence over national codes. In the absence of local codes, refer to the latest edition of the National Electric Code (NEC) in the local government Electric Code (CEC) for installation.

DANGER

— Risk of electrical shock or electrocution.



The electrical supply to this product must be installed by a licensed or certified electrician in accordance with the National Electrical Code and all applicable local codes and ordinances. Improper installation will create an electrical hazard which could result in death or serious injury to heat pump users, installers, or others due to electrical shock, and may also cause damage to property. Read and follow the specific instructions inside this guide.



WARNING - To reduce the risk of injury, do not permit children to use this product unless they are closely supervised at all times.

Consumer Information and Safety

The EVI DC Inverter Air Source Heat Pumps are designed and manufactured to provide years of safe and reliable service when installed, operated and maintained according to the information in this manual and the installation codes referred to in later sections. Throughout the manual, safety warnings and cautions are identified by the “” symbol. Be sure to read and comply with all of the warnings and cautions.

Heat Pump Energy Saving Tips

If you do not plan to use hot water for a prolonged period, then you might choose to turn the heat pump off or decrease the temp. setting of the control several degrees to minimize energy consumption.

We offer the following recommendations to help conserve energy and minimize the cost of operating your heat pump without sacrificing comfort.

1. A maximum water temp. of 60°C is recommended.
2. It is recommended to turn off the heat pump when ambient air temp. is less than -30°C or if on vacation for longer than a week.
3. To save energy, it is recommended that the heat pump is operated during daytime when the ambient temp. is higher.
4. Try to install the heat pump at the ventilated places indoor. If it must be installed outdoor, where possible, shelter the heat pump from prevailing winds, rain and snow. Always use a shelter when practical, which will reduce the possibility of frosting and icing.

General Installation Information

1. Installation and service must be performed by a qualified installer or service agent, and must conform to all national, state, and local codes and/or safety regulations.
2. This EVI DC Inverter Air Source Heat Pump is specifically designed for domestic hot water & house heating.

Section 1

Introduction

Product Overview

EVI DC Inverter Air Source heat pumps transfer heat from the ambient air to water, providing high-temp. hot water up to 60°C. The unique high-temp. heat pump is widely used for house warming. With innovative & advanced technology, the heat pump can operate very well at -30°C ambient temp. with high output temp.s up to 60°C, which ensures the compatibility with normal sized radiator based systems without supplementation. Compared with traditional oil/LPG boilers, EVI DC Inverter heat pump produces up to 50% less CO₂ whilst saves 80% running cost. Our heat pumps are not only highly efficient, but also easy and safe to operate.

General Features

1. Low running costs and high efficiency
 - A high coefficient of performance (COP) of up to 5 results in lower running costs compared with traditional ASHP technology.
 - No immersion heater supplement is required.
2. Reduced Capital Costs
 - Simple installation
3. High Comfort Levels

- High storage temp. results in increased hot water availability.
- 4. No potential danger of any inflammable, gas poisoning, explosion, fire, electrical shock which are associated with other heating systems.
- 5. A digital controller is incorporated to maintain the desired water temp..
- 6. Long-life and corrosion resistant composite cabinet stands up to severe climates.
- 7. American Copeland compressor ensures outstanding performance, ultra-energy efficiency, durability and quiet operation.
- 8. Self-diagnostic control panel monitors and troubleshoots heat pump operations to ensure safe and reliable operation.
- 9. Intelligent digital controller with friendly user interface and blue LED back light.
- 10. Separate isolated electrical compartment prevents internal corrosion and extends heat pump life.
- 11. The heat pump can operate down to ambient air temp. of -30°C.

Section 2

Installation

The following general information describes how to install the EVI DC Inverter air source heat pump.

Note: Before installing this product, read and follow all warning notices and instructions. Only a qualified service person should install the heat pump.

Materials Needed for Installation

The following items are needed and are to be supplied by the installer for all heat pump installations:

1. Plumbing fittings.
2. Level surface for proper drainage.
3. Ensure that a suitable electrical supply line is provided. See the rating plate on the heat pump for electrical specifications. Please take a note of the specified current rating. No junction box is needed at the heat pump; Connections are made inside of the heat pump electrical compartment. Conduit may be attached directly to the heat pump jacket.
4. It is advised to use PVC conduit for the electrical supply line.
5. Use a booster pump for pumping water in case of low water pressure.
6. A filter on the water inlet is needed.
7. The plumbing should be insulated to reduce its heat loss.

Note: We recommend installing shut-off valves on the inlet and outlet water connections for ease of serviceability.

DC Inverter Heat Pump for cooling, heating and DHW (R32)			
Product/ model		3E040-DKZLRS-C	3E060-DKZLRS-C
Heating	Heating Capacity (kW) Range	6.5~12.6	10.5~22
	Heating input Range (kW)	1.41~2.99	2.27~5.2
	current Range (A)	6.45~13.7	4.06~9.30
	COP Range	4.21~4.62	4.23~4.63
Cooling	Cooling capacity Range (kW)	4.2~8.2	7.2~14.2
	Cooling input power (kW)	1.30~3.33	2.17~5.55
	current Range (A)	5.96~15.3	3.88~9.93
	EER Range	2.46~3.23	2.56~3.32
DHW	Heating Capacity (kW) Range	5.5~10.5	8.8~17.5
	Heating input Range (kW)	1.42~3.42	2.24~5.61
	Current Range (A)	6.51~15.7	4.01~10.0
	COP Range	3.07~3.86	3.12~3.93
Refrigerant		R32	
Power supply		230V/1Ph/50-60Hz	380V/3Ph/50-60Hz
Working area		-30~43°C	
Water circulation (m ³ /H)		2.17	3.78
Water pressure drop (kPa)		25	30
IP Grade (Level of protection)		IPX4	IPX4
Anti-electric shock Rate		I	I
Noise (dB(A))		≤53	≤58
Net weight/Gross weight (kg)		90/100	140/155
Water Connection (mm)		DN25	
Water Head (m)		9m	12m
Electric Heater(kW)		3	
Operating water temperature (°C) DHW		20~55°C	
Operating water temperature (°C) heating		20~50°C	
Operating water temperature (°C) cooling		7~35°C	
Remark: Heating working condition: Inlet water temperature 30°C, Outlet water temperature 35°C, Dry bulb temperature 7°C, Wet bulb temperature 6°C. Cooling working condition: Inlet water temperature 12°C, Outlet water temperature 7°C, Dry bulb temperature 35°C, Wet bulb temperature 24°C. DHW working condition: Inlet water temperature 15°C, Outlet water temperature 55°C, Dry bulb temperature 7°C, Wet bulb temperature 6°C.			

Note:

The above design and specifications are subject to change without prior notice for product improvement. Detailed specifications of the units please refer to nameplate on the units.

Correct installation is required to ensure safe operation. The requirements for heat pumps include the following:

1. Dimensions for critical connections.
2. Field assembly (if required).
3. Appropriate site location and clearances.
4. Proper electrical wiring.
5. Adequate water flow.

This manual provides the information needed to meet these requirements. Review all application and installation procedures completely before continuing the installation.

Installation Location



CAUTION!

1. DO NOT install the heat pump near to hazardous materials and places
2. DO NOT install the heat pump under deep sloping roofs without gutters which will allow rain water, mixed with debris, to be forced through the unit.
3. Place the heat pump on a flat slightly pitched surface, such as concrete or fabricated slab. This will allow proper drainage of condensation and rain water from the base of the unit. If possible, the slab should be placed at the same level or slightly higher than the filter system/equipment.

Installation Details

All criteria given in the following sections reflect minimum clearances. However, each installation must also be evaluated, taking into account the prevailing local conditions such as proximity and height of walls, and proximity to public access areas. The heat pump must be placed to provide clearances on all sides for maintenance and inspection.

1. The heat pump installation area must have good ventilation and the air inlet/outlet must not be hindered.
2. The installation area must have good drainage and be built on a solid foundation.
3. Do not install the unit in areas accumulated with pollutions like aggressive gas (chlorine or acidic), dust, sand and leaves etc.
4. For easier and better maintenance and troubleshooting, no obstacles around the unit should be closer than 1m. And no obstructions within 2m, vertically, from the unit for air ventilation.
(See Figure 1)

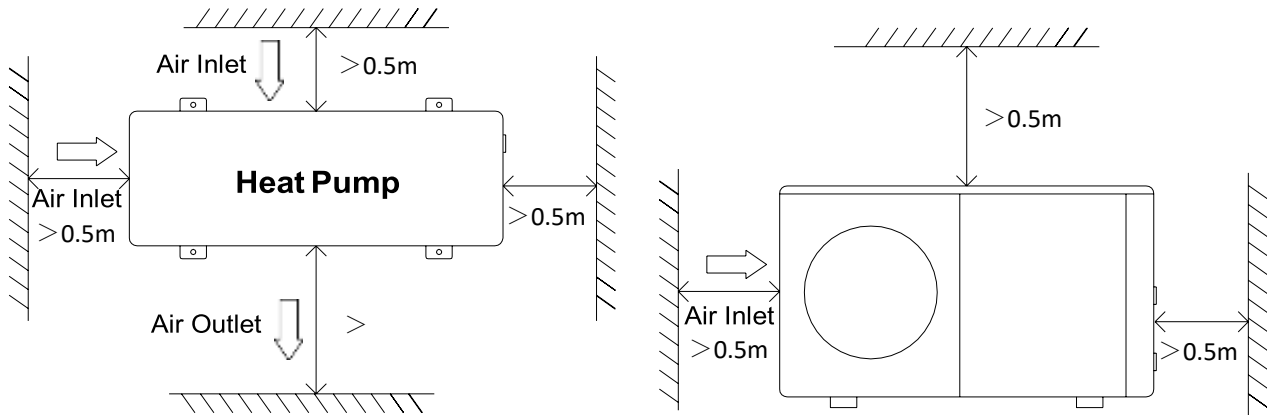

Figure 1

5. The heat pump must be installed with shockproof bushes to prevent vibration and/or imbalance.
6. Even though the controller is waterproof, care should be taken to avoid direct sunlight and high temp. In addition, the heat pump should be placed to ensure quality viewing of the controller.
7. The plumbing pipes must be installed with proper support to prevent possible damage due to vibration.

Running water pressure should be kept over 196kpa. Otherwise, booster pump should be installed.

8. The acceptable operating voltage range should be within $\pm 10\%$ of the rated voltage.
 - The heat pump unit must be grounded /earthed for safety purposes.

Drainage and Condensation

Condensation will occur from the evaporator when the unit is running and drain at a steady rate, depending upon ambient air temp. and humidity. The more humid the ambient conditions, the more condensation will occur. The bottom of the unit acts as a tray to catch rainwater and condensation. Keep the drain holes, located on the bottom pan of the unit base, clear from debris at all times.

Suggested Installation Methods

1. For heating + hot water installation

- 1) System installation diagram to see Figure 2.
- 2) Electrical wiring diagram to see Figure 3.
- 3) Controller panel setting to see Figure 4. Figure 5 and Figure 6. Figure 4 shows that it is running in hot water mode, Figure 5 /Figure 6 shows that it is running in heating or cooling mode.
- 4) When both heating(or cooling) and domestic hot water don't reach the setting temp., hot water is priority.

- a) The hot water tank with coil for domestic hot water should be specially customized.
- b) The heat exchange capacity of the coil should be \geq the rated heating capacity of the heat pump.
- c) The head of the circulation pump should be big enough. Its actual water flow cannot be less than water flow on nameplate.

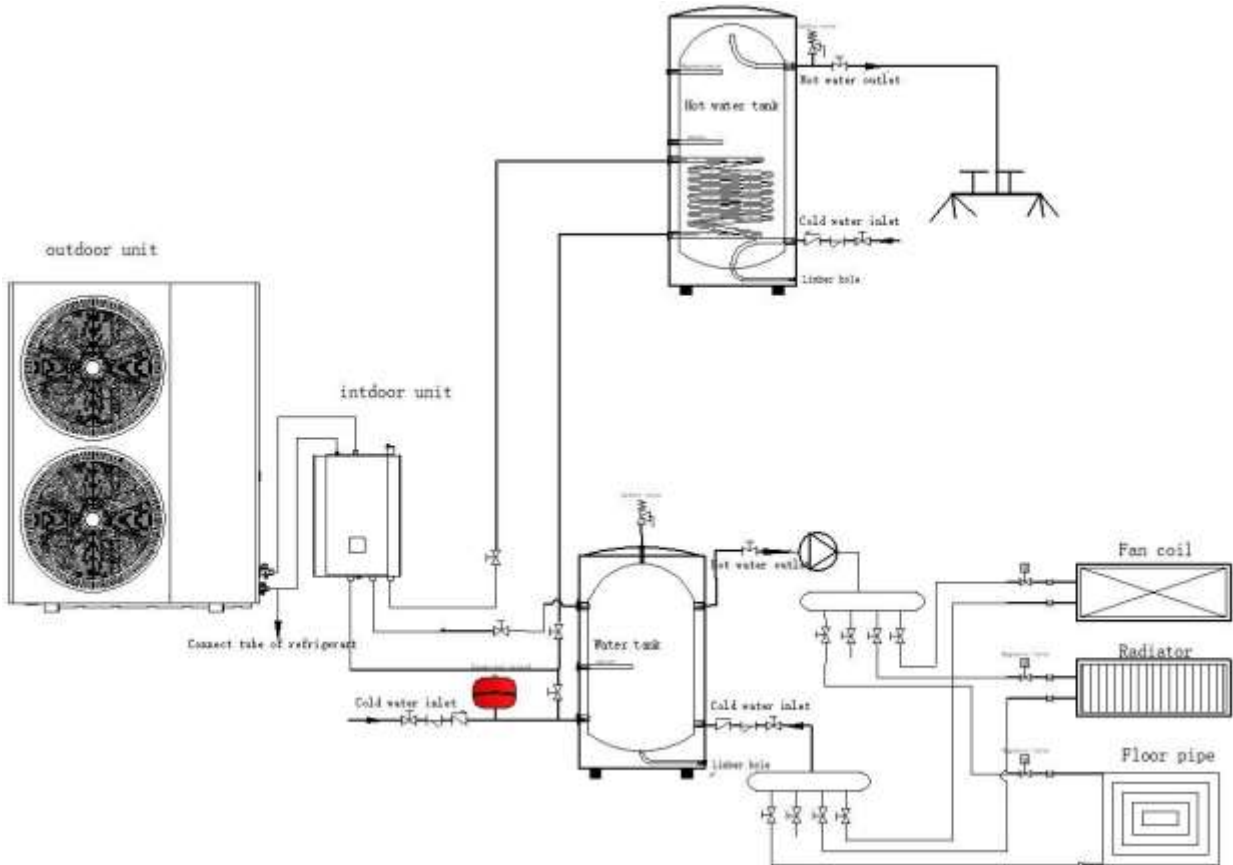

Heat pump for heating and hot water
Figure 2



Figure 3



Figure 4

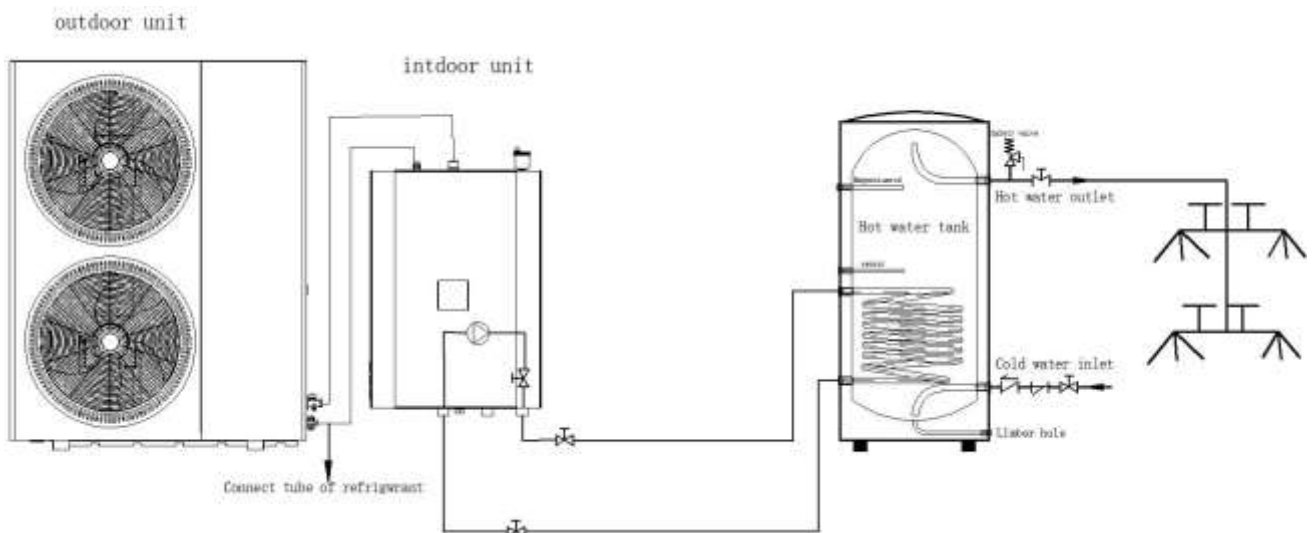

Figure 5



Figure 6

2. For only hot water installation



Heat pump for hot water

Figure 7



Figure 9

3. For heating and cooling installation

- 1) System installation diagram to see Figure 10.
- 2) Controller panel setting to see Figure 12 and Figure 13. The inlet water setting temp. of the heating or cooling mode can be adjusted by Target temperature setting interface.
- 3) The head of circulation pump should be big enough. Its actual water flow cannot be less than water flow on nameplate .

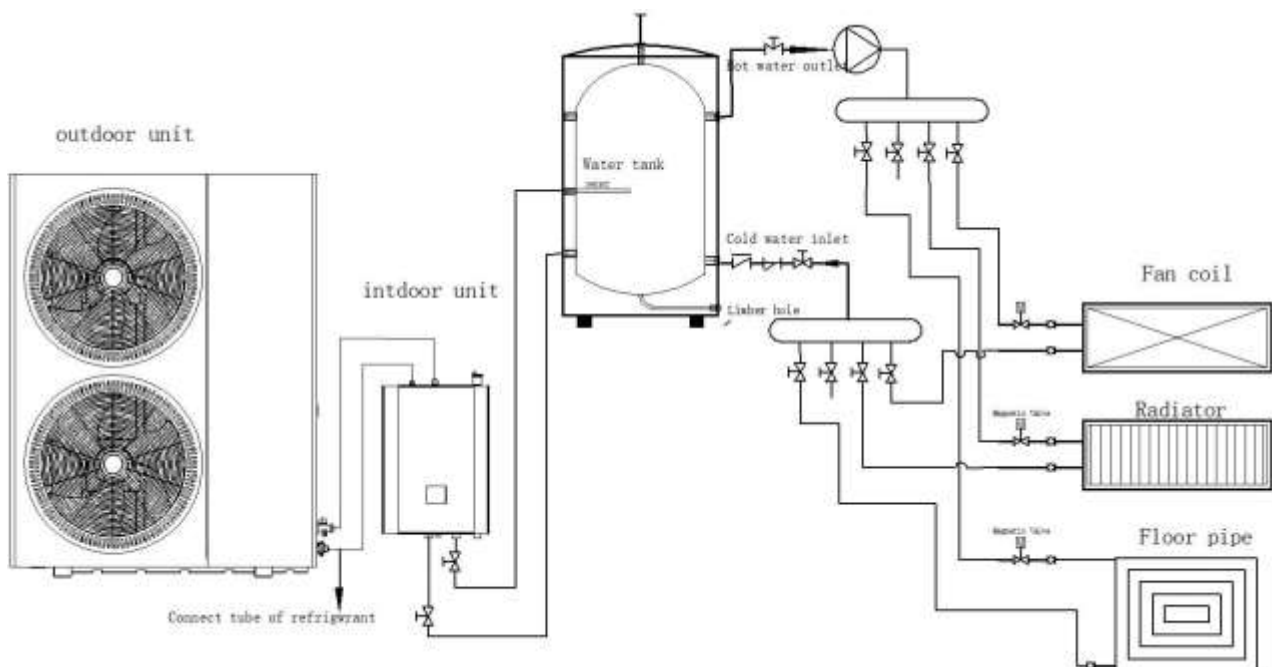

Heat pump for heating

Figure 10



Figure 12



Figure 13

Water Connections

Water Connections at the Heat Pump

Quick Connect fittings are recommended to be installed on the water inlet and outlet connections. It is recommended to use stainless steel or PPR pipes for the heat pump plumbing. The water inlet and outlet connection to the heat pump accepts stainless steel or PPR pipe fittings.

⚠ CAUTION — Make sure that flow requirements and tap water turnover rates can be maintained with the installation of additional heat pumps and plumbing restrictions.

Plumbing Installation Requirements

1. When water pressure exceeds 490Kpa, please use reducing valve to reduce the water pressure below 294Kpa.
2. Each part connected to unit needs to be connected with method of loose joint and installed with intermediate valve.
3. Ensure that all plumbing has been properly completed and then proceed to do a water leakage and pressure test.
4. All the pipelines and pipe fittings must be insulated to prevent heat loss.
5. Install a drain valve at the lowest point of the system to enable the system to be drained during freezing conditions (winterizing).
6. Install a check valve on the water outlet connection in order to prevent back siphoning when water pump stops.

7. In order to reduce the back pressure, the pipes should be installed horizontally
8. And minimize the elbows (90 degrees connections). If a higher flow rate is required, install a bypass valve

Electrical Connections



WARNING —Risk of electrical shock or electrocution.



Ensure that all high voltage circuits are disconnected before commencing heat pump installation. Contact with these circuits could result in death or serious injury to users, installers or others, due to electrical shock and may also cause damage to property.



CAUTION — Label all wires prior to disconnection when servicing the heat pump. Wiring errors can cause improper and dangerous operation. Check and ensure proper operation after servicing.

Power Supply

1. If the supply voltage is too low or too high, it can cause damage and/or result in unstable operation of the heat pump unit, due to high inrush currents on start up.
2. The minimum starting voltage should be above 90% of rated voltage. The acceptable operating voltage range should be within $\pm 10\%$ of the rated voltage.
3. Ensure the cable specifications meet the correct requirements for the specific installation. The distance between the installation site and mains power supply will affect the cable thickness. Follow the local electrical standards to select the cables, circuit breakers and isolator breakers.

Grounding and Over Current Protection

In order to prevent electrical shock in case of leakage from unit, install the heat pump according to local electrical standard.

1. Do not interrupt the voltage supply to the heat pump frequently as this may result a shorter life expectancy of the heat pump.
2. When installing over current protection, ensure that the correct current rating is met for this specific installation.
3. The Compressor, fan coil unit and heat pump water pump all have AC-contactor and thermo relay protection. Therefore, in the process of installation and debugging, firstly measure each of the aforementioned components' current, and then adjust the current protection range of the thermo relays.

Electrical Wiring Diagram 3E050-DKZLRS-C

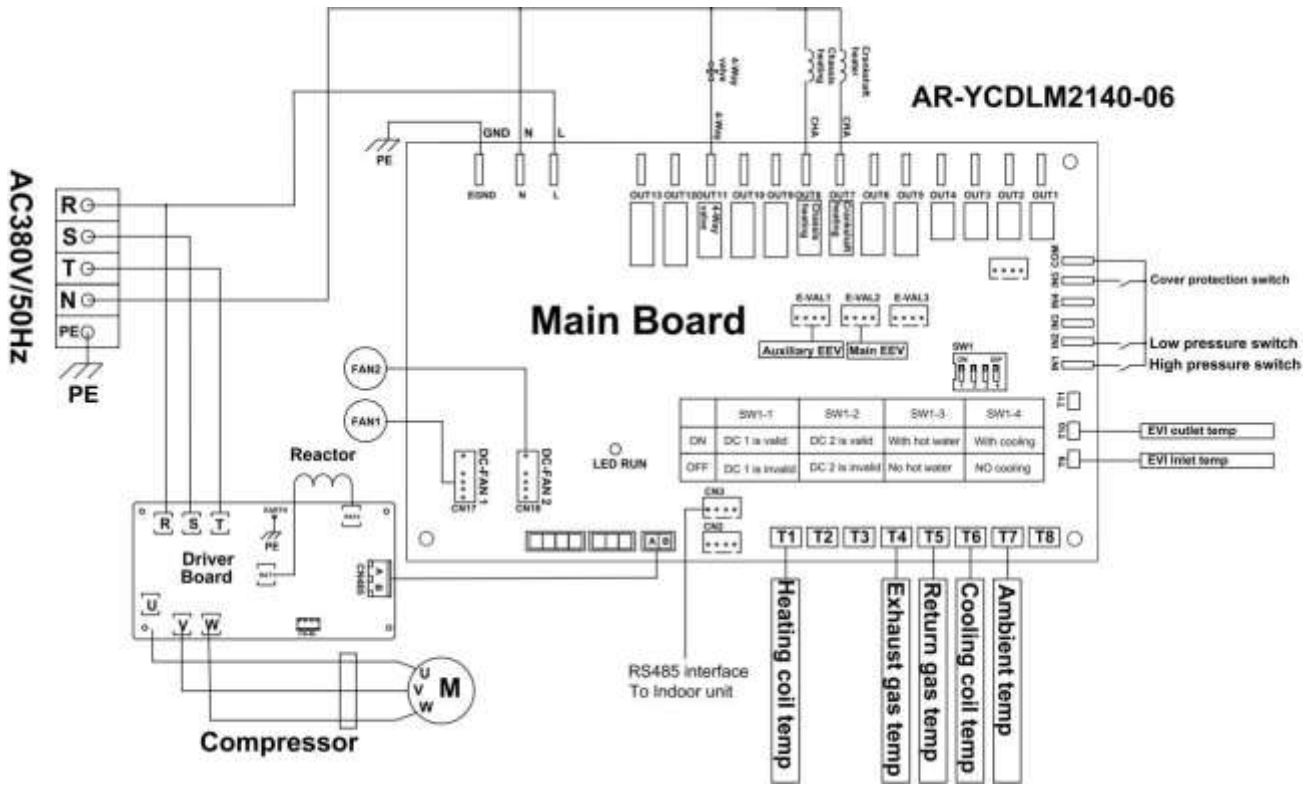

3E030-DKZLRS-C

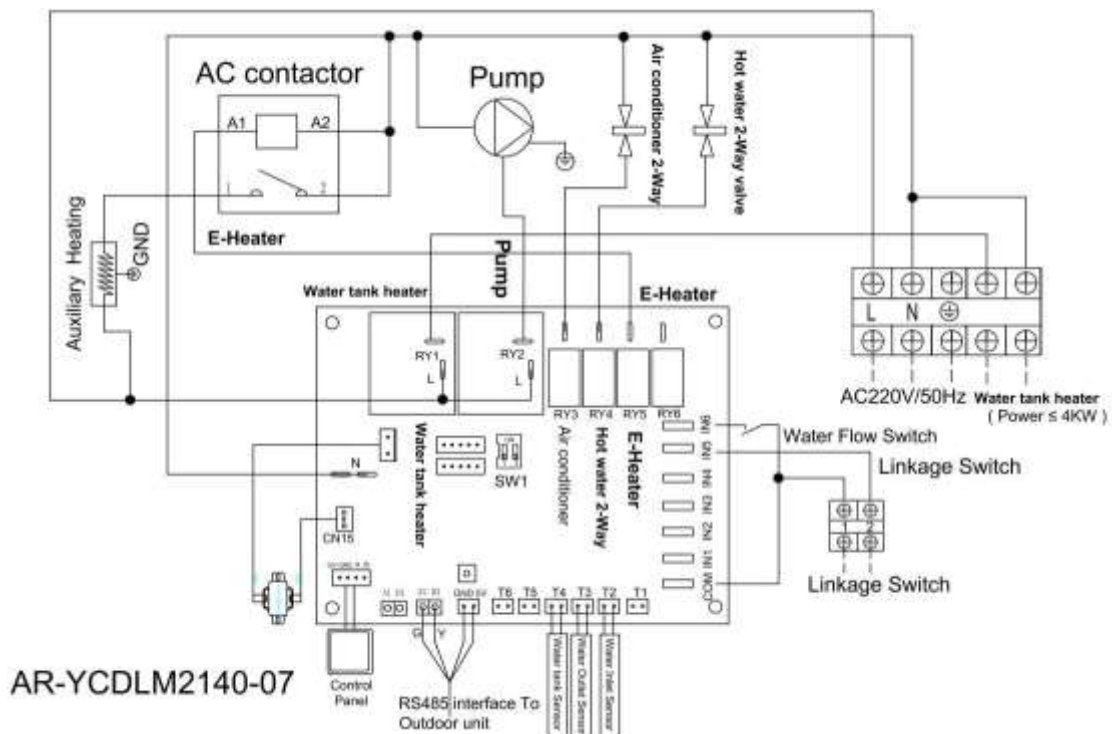

Section 3

Operating Heat Pump

Controller Panel











Turn off status (All buttons in gray)

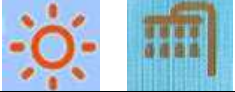
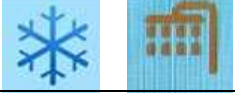













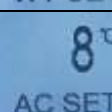

Turn on status (All buttons in orange)

1. Display Icon

Mode	Meaning
	Heating mode
	Hot water mode
	Cooling mode
	Heating and Hot water Mode (Hot water function as priority)
	Cooling and Hot water Mode (Hot water function as priority)
	Compressor working
	Water pump working
	Fan motor working
	Electric heating working
	Error showing

2. Definition of Buttons

Button	Description	Function
	On/off	turn on or turn off the heat pump.
	Mode	switch the operating mode of the heat pump.
	Timer	set timer switch and working weekdays.
	Setting	query running parameters, check and set system parameters, error code records, Wifi connection, etc.
	Set	set water tank target temperature at only hot water mode, or return water temperature at only heating/only cooling mode.
	WT SET	Set water tank target temperature at heating+hot water mode or cooling+hot water mode.
	AC SET	Set return water target temperature of heating/cooling at heating+hot water mode/cooling+hot water mode)
	Temp	display real-time water tank temperature at only hot water mode, or real-time return water temperature of heating/cooling at only heating/only cooling mode.
	WT TEMP AC TEMP	WT TEMP: display real-time water tank temperature at heating+hot water or cooling+hot water mode. AC TEMP: display real-time return water temperature of heating/cooling at heating+hot water or cooling+hot water mode.
	Status	Check the running parameters of the heat pump
	Faulty	Record the most recent error codes
	Wifi	Wifi setting
	System parameters	Check and set the system parameters of the heat pump
	Factory parameters	Check and set the factory parameters(Do not advise to amend the factory parameters.

3. Wire Controller Operation

START / STOP THE HEAT PUMP

©In the main interface, press ON/OFF button for around 1 seconds to turn on or turn off the heat pump.



Turn off status (All buttons in gray)



Turn on status (All buttons in orange)

RUNNING MODE SETTING:

- ©When the heat pumps is ON and in the main interface, press MODE button for around 1 seconds to switch the running modes. (5 modes optional: heating only, cooling only, DHW only, heating + hot water, cooling + hot water)
- ©Under heating + hot water mode or cooling + hot water mode, the hot water function will be met as priority.
- ©Under heating or cooling mode, the TEMP icon in the interface shows the real-time return water temp. Under hot water mode, TEMP icon shows the real-time water tank temp.



For example, switch running mode from heating to cooling

SET TARGET WATER TEMPERATURE

©In the main interface, press SET button to enter Target temp. setting interface(as below). Typing the target temp. value, then press “Enter” to save and exit, or press “Esc” to exit without saving.



CLOCK SETTING:

©In the main interface, press **14 : 40** to enter clock setting interface as below.

©Press the date (Year/Month/Day column) or hour (Hour: Minute column) , the keyboard will occur to input the value. Press the weekday(Weekday column) to switch from Mon. to Sun.

©Press CONFIRM button to save and exit, or press CANCEL button to exit without saving.

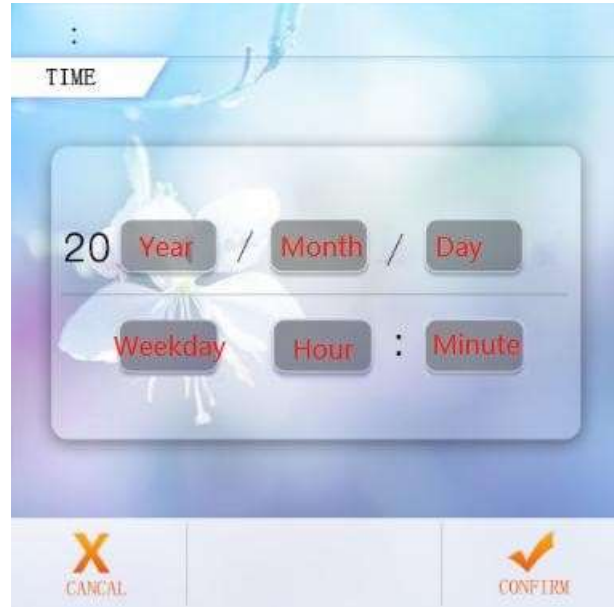

TIMER SETTING:

©In the main interface, press TIMER button to enter timing setting interface.

©In the WEEK column, users can select which weekdays to perform timer switch. When the weekday button (From MON. to SUN.) turns orange, the timer will perform on that day. When the weekday button turns gray, the timer will not perform on that day.

©In the TIMER column, users can set 4 pairs of timer at maximum

©The timer is invalid when the turn on time equals the turn off time in the same timer.



OPERATION PARAMETER QUERY

©Press “SETTING” in the main interface to enter setting interface. Then press “STATUS” to enter Parameter Query to check the operation status of heat pumps. The list as below:



©List of operation parameters

Code	Description	Remark
01	Water inlet temp.	-30~99°C
02	Water outlet temp.	-30~99°C
03	Ambient temp.	-30~99°C
04	Exhaust gas temp.	0~125°C
05	Return gas temp.	-30~99°C
06	Evaporator coil temp.	-30~99°C
07	Inlet temp. of economizer	-30~99°C
08	Outlet temp. of economizer	-30~99°C
09	Cooling coil temp.	-30~99°C
10	Water tank temp.	-30~99°C
11	Opening of main expansion valve	
12	Opening of assistant expansion valve	
13	Compressor current	
14	Heat sink temp.	
15	DC bus voltage value	
16	Compress actual frequency	
17	Low pressure gauge pressure value (R410)	Real time data(Bar)
18	High pressure gauge pressure value (R410)	Real time data(Bar)
19	Wind speed of DC fan 1	
20	Wind speed of DC fan 2	
21	Low pressure conversion temp.	
22	High pressure conversion temp.	

SYSTEM PARAMETERS QUERY & SETTING

© Press “SETTING” in the main interface to enter setting interface, then press “SYSTEM PARAMETERS” to enter parameter query and setting. Below lists shows the code, definition, range and default value.



©List of system parameters

Code	Definition	Settable Range	Default
P01	Temp difference of return water and cooling target temp	2°C~18°C	2°C
P02	Temp difference of return water and hot water target temp	2°C~18°C	5°C
P03	Hot water setting temp.	28°C~60°C	50°C
P04	Cooling setting temp.	7°C~30°C	12°C
P05	Heating setting temp.	15°C~50°C	35°C
P06	Setting temp of exhaust gas too high protection (TP4)	50°C~125°C	120°C
P07	Setting temp of exhaust gas too high recover (tp0)	50°C~125°C	95°C
P08	Water temp. compensation	-5°C~15°C	(inlet/outlet water tank)
P09	Defrosting frequency	30-120HZ	60HZ
P10	Defrosting period	20MIN~90MIN	45MIN
P11	Defrosting enter temp.	-15°C~-1°C	-3°C
P12	Defrosting time	5MIN~20MIN	10MIN
P13	Defrost exit temp.	1°C~40°C	20°C
P14	Defrosting environment and evaporator coil temp. difference 1	0°C~15°C	5°C
P15	Defrosting environment and evaporator coil temp. difference 2	0°C~15°C	5°C
P16	Ambient temp. for defrosting	0°C~20°C	17°C
P17	High temperature disinfection cycle days	0~30 days Disinfection function is	7

		not executed when set to 0	
P18	High temperature disinfection start time	0~23:00	23
P19	High temperature disinfection sustaining time	0~90min	30
P20	High temperature disinfection setting temperature	0~90°C	70°C
P21	Heat pump's setting temperature for high temperature disinfection	40~60°C	53°C
P22	Heating target temperature automatic adjustment enable	0~1 (0 is not enabled, 1 is enabled) (only applicable at heating mode)	0
P23	Heating compensation temperature point (ambient temperature)	0-40	20
P24	Target temperature compensation coefficient	1~30 (1 corresponds to actual 0.1)	1

High Temperature Antisepsis Function: (when hot water function is selected)

- ⊙ High temperature Antisepsis cycle is once every 7 (P17) days;
- ⊙ When entering the high temperature Antisepsis, the water tank electric heater will be forced to turn on.
- ⊙ During the Antisepsis process, if the water tank temperature > 60°C (the maximum settable temperature), then the compressor will not start, but only start electric heating; if the water tank temperature ≤ 55°C, both the compressor and electric heater will start.
- ⊙ When the water tank temperature ≥ 65°C (P20) and the protection temperature lasts for 15 minutes (P19) ≥ 65°C, exit the high temperature Antisepsis;
- ⊙ After entering high temperature Antisepsis, if the temperature of the hot water tank does not reach 65°C after 1 hour, the high temperature Antisepsis program will be forced to exit;

Target Temperature Auto Adjustment Logic (Under Heating Mode)

- ⊙ The target temperature under heating mode can be automatically adjusted according to the ambient temperature.
- ⊙ Entry conditions
When Parameter P22=1 enables automatic adjustment mode of heating target temperature.
- ⊙ Calculation formula of heating target temperature
Pset (heating target temperature) = P23 + (P24/10) * (P23 - current ambient temperature)

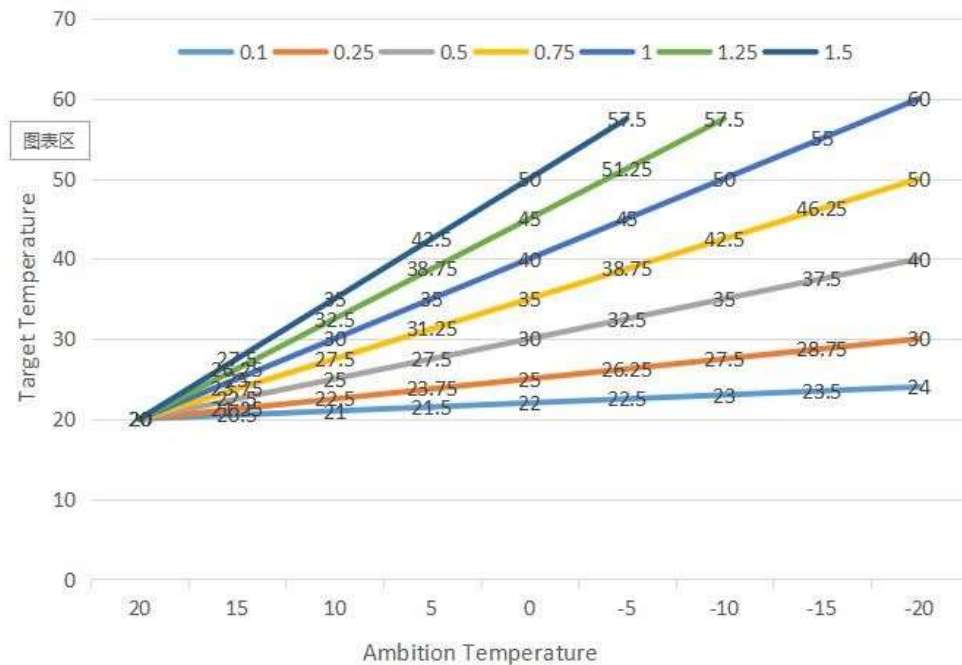

◎The above different curves stands for the different value of P24.

(When P24=1, the actual value is 0.1)

◎The target temperature range of automatic temperature adjustment is 20-60°C

Auxiliary Electric Heater for Water Tank

◎Start conditions (all below conditions must be met at the same time)

- 1) In hot water mode;
- 2) The compressor runs for 50 minutes;
- 3) There is a demand for hot water, and the temperature of the water tank is $\leq 55^\circ\text{C}$;
- 4) The pump is running

◎Exit condition (only need to meet any one of the below conditions)

- 1) When the heat pump is performing cooling mode / hot water mode;
- 2) When there is no demand for hot water or constant temperature control;
- 3) The water tank temperature sensor has a fault alarm;

◎When it is under defrosting / forced defrosting / secondary antifreeze , the electric heating is forced to turn on;

◎ When there is high-pressure failure / low-pressure failure / exhaust temperature sense failure / excessive exhaust protection stop, and if compressor is locked and cannot be started, then the electric heating will be started instead of the compressor after 5 minutes.

General Operating Guide

Initial Start-up Precautions

First boot-strap and Running state checks

1. To ensure the power same as the product nameplate required power.
2. Unit electrical connections: Check if power supply wire track and connection is ok; if ground wire is properly connected; Check if water pump and other chain device is properly connected
3. Water pipe and pipe: water pipe and pipe must be washed two and three times, ensure clean and no any pollution.
4. Check water system: If the water is enough and no any air, ensure no leakage
5. First boot-strap or starting up again after long time stop, ensure power on ahead and heating at least 12 hours for crankcase (local loop temp. is zero). Water pump start up first, last a while, fan start up, compressor start up, unit regular work.
6. Running checks (according to the following data to check if the unit running is normal)
After unit normal running, check the following item:
 - a. Input and output water temp.
 - b. cycle water flow of the side
 - c. running electric current of compressor and fan
 - d. High and low pressure value when heating running.



CAUTION — Refrain from using this heat pump if any electrical components have been in contact with water. Immediately call a qualified service technician to inspect the heat pump.



CAUTION — Keep all objects clear above the heat pump. Blocking air flow could damage the unit and may void the warranty.

Users' Guide

1. Rights and Responsibility

- 1.1 To ensure you have the service in guarantee period, only the professional server and technology staff can install and repair the unit. If you infract this request and cause any loss and damage, our company will not be claimed any responsibility.
- 1.2 After receiving the unit, check if have damage on shipment and all parts are complete; any damage and lack of parts please notice the dealer in written.

2. User Guide

- 2.1 All safety protection device are set in unit before leaving factory, don't adjust by yourself.
- 2.2 Unit have enough refrigerant and lubricating oil, don't fill or replace them; if need fill owing to leak, please refer to the quantity on nameplate (if refill refrigerant, need re-vacuum).
- 2.3 External water pump must connect with the message of unit, or else easy show various water lack alarm.

- 2.4 Regular clean water system according to maintenance request.
- 2.5 Pay attention to antifreeze when the environment temp. is less than zero in winter.
- 2.6 Safety Precautions
 - A User can't self-install the unit, ensure agent or specialized install company to do, or else maybe cause safety accident and affect the use effect.
 - B When install or use the unit, please check if the power is corresponding with unit power.
 - C The main power switch of unit should install leakage protector; the power cord must meet unit power request and national standard and local Fire & Safety Regulations.
 - D Unit must have ground wire; don't use the unit if no ground wire; forbid connect the ground wire to null line or water pump.
 - E The main power switch of unit should set much higher 1.4 meter (child don't touch it), to prevent child play it and cause danger.
 - F More than 52°C hot water can cause damage, hot and cold water must be mixed then use it.
 - G When unit is soaking, please contact the factory or maintain department, you can use it again after maintain.
 - H Forbid insert any tools into fan fence of unit, fan is dangerous. (child special care)
 - I Don't use the unit if turn off the fan fence.
 - J To avoid electric shock or cause fire, don't store and use fixture, oil paint and petrol etc. combustible gas or liquid around the unit; don't throw the water or other liquid on the unit and don't touch the unit by wet hand.
 - K Don't adjust the switch, valve, controller and internal data except company server or authorized staff.
 - L If safety protection device often start up, please contact factory or local dealer.

Section 4

General maintenance

Controller Error Codes

- ☉ If there's error in the heat pumps, the error code and error definition will be displayed in the main interface, and saved the record in FAULTY column inside the SETTING interface.
- ☉ The following Common Error Codes will be displayed on the controller panel:

Error Code	Definition of Error or Protection
Er 03	Water flow failure
Er 04	Antifreeze in winter
Er 05	High pressure fault
Er 06	Low pressure fault

Er 09	Communication failure
Er 10	Communication failure of frequency conversion module (alarm when communication between outer board and drive board is disconnected)
Er 12	Exhaust temp too high protection
Er 14	Water tank temp. sensor fault
Er 15	Water inlet temp. sensor fault
Er 16	Evaporator coil temp. sensor fault
Er 18	Exhaust temp. fault
Er 20	Abnormal protection of frequency conversion module
Er 21	Ambient temp. sensor fault
Er 23	Cooling outlet water temp. supercooling protection
Er 26	Heat sink temp. fault
Er 27	Outlet water temp. sensor fault
Er 29	Return gas temp. sensor fault
Er 32	Heating too high outlet water temp. protection
Er 33	Coil temp. too high
Er 34	The temp. of frequency conversion module is too high
Er 42	Cooling coil temp. sensor failure
Er 62	Inlet temp. fault of economizer
Er 63	Outlet temp. failure of economizer
Er 64	DC fan 1 fault
Er 66	DC fan 2 fault
Er 67	Low pressure switch failure
Er 68	High pressure switch failure
Er 69	Too low pressure protection
Er 70	Too high pressure protection

© When there's Er 20 error in the system, it will display below detailed error code from 1 to 348. Among them, 1~128 are in the first class, when will be displayed as priority, 257~384 are in the second class, which will be displayed only when error 1~128 don't appear. If 2 or more than 2 error occurs simultaneously in the same class, then it will display the sum of the error number. For example, when 16 and 32 exist at the same time, then it will display error code 48 (16+32=48)

© Detailed error code list for Er 20:

Error Code	name	description	Solution suggestion
1	IPM Over-current	IPM Module problem	Replace inverter module
2	compressor synchronous abnormal	Compressor failure	Replace compressor
4	reserved	--	--
8	compressor output phase absent	Compressor wiring disconnected or poor contact	Checking compressor input circuit
16	DC bus low voltage	Input too low voltage, PFC module failure,	Inspect the input voltage, replace module
32	DC bus high voltage	Input voltage too high, PFC Module failure	Replace inverter module
64	Radiator over temperature	Main unit fan motor failure, air duct blockage	Inspect fan motor, air duct
128	Radiator temperature error	Radiator sensor short circuit or open circuit fault	Replace inverter module
257	communication failure	Inverter module doesn't receive order from main controller	Inspect the communication wiring= between main controller and inverter module
258	AC Input phase absent	Input phase absent (Three phase module is effective)	Inspection input circuit
260	AC Input over-current	Input three phase imbalance (three phase module is effective)	Inspection input three phase phase voltage
264	AC Input low voltage	Input low voltage	Inspect input voltage
272	Compressor High pressure failure	Compressor high pressure failure (reserved)	
288	IPM too high temperature	Main unit fan motor failure, air duct blocked	Inspect fan motor and air duct
320	Compressor peak current too high	Compressor line current too high, the driver program doesn't match with compressor	Replace inverter module
384	PFC module over-temperature	PFC Module too high temperature	

Owner Inspection

We recommend that inspections on heat pumps are done frequently, especially after abnormal weather conditions. The following basic guidelines are suggested for your inspection:

1. Make sure the front of the unit is accessible for future service.
2. Keep the top and surrounding areas of the heat pump clear of all debris.
3. Keep all plants and shrubs trimmed and away from the heat pump especially the area above the fan.
4. Keep lawn sprinklers from spraying on the heat pump to prevent corrosion and damage.
5. Ensure that the ground wire is always properly connected.
6. The filter must be maintained on a regular basis in order to ensure clean and healthy water to protect the heat pump from damaging.

7. Keep inspecting power and electrical components' wiring to make sure their normal operation.
8. All the safety protection devices have been set up; please refrain from changing these settings. If any changes are needed, please contact the authorized installer/agent.
9. If the heat pump is installed under roof without a gutter, ensure that all measures are taken to prevent excessive water from flooding the unit.
10. Do not use this heat pump if any electrical part has been in contact with water. Contact an authorized installer/agent.
11. If the increase of power consumption is not due to colder weather, please consult with the local authorized installer/agent.
12. Please turn off the heat pump and disconnect it from the mains power supply, when not in use for a prolonged period of time.

Troubleshooting

Use the following troubleshooting information to resolve issues/problems with your EVI DC Inverter heat pump.

WARNING — RISK OF ELECTRICAL SHOCK OR ELECTROCUTION.



Ensure that all high voltage circuits are disconnected before commencing heat pump installation. Contact with these circuits could result in death or serious injury to users, installers or others, due to electrical shock and may also cause damage to property.

DO NOT open any part of the heat pump as this may result to electrocution.

1. Keep your hands and hair clear of the fan blades to avoid injury.
2. If you are not familiar with your heater:
 - a) **DO NOT** attempt to adjust or service the unit without consulting your authorized installer/agent.
 - b) **PLEASE** read the complete Installation and/or User's Guide before attempting to operate service or adjust the heater.

IMPORTANT: Turn off the mains power supply to the EVI DC Inverter heat pump prior to attempting service or repair.

Maintenance

The EVI DC Inverter air source heat pump unit is highly automation device. If the units are cared and maintained effectively regularly, the operation reliability and the lifetime of the unit will be highly improved.

Important tips below shall be paid more attention to when doing the maintenance:

1. The water filter shall be cleaned termly, to make sure the water is clean, and avoid any damage caused by the filter blockage.
2. All the safety protection device set up already before leaving the factory, forbid to adjust by oneself. We could not take any responsibility for any unit damage caused by the user's self-adjustment.
3. The surrounding of the unit shall be clean, dry and draughty. If the side of the heat exchanger could be cleaned termly(every 1-2 month), the heat exchanging efficiency will be better, and energy saving.
4. The water supplement of water system and air discharge device shall be checked frequently, to avoid the air to enter the system, causing the water circulation decrease, or the water cycle trouble, or it will effect the unit's cooling, heating efficiency and the working reliability .
5. The power of the unit and the electrical wiring shall be checked frequently, make sure the wiring is fastened and the electrical component is normal. If abnormal, it shall be repaired or replaced, the unit shall be connected to the ground reliably.
6. Check every components during the unit operation frequently. Check whether the working pressure of cooling system is normal or not. Check the pipe splice and the air injection valve whether have greasy dirt. Make sure not any refrigerant leakage in the cooling system.
7. Don't stack any sundries around the unit, in case blocking the air inlet and outlet. The surrounding of the unit shall keep clean, dry and draughty.
8. The water in the water system shall be discharged if the unit need to take a long break after running for a period. And the power shall be off, put a cover on the unit. Only after the water system is replenished full with water and the unit is checked roundly, and the unit is power on to warm up for at lease 6 hours, all is fine, then the unit could be started up again.

Notice:

The unit should be equipped with the dedicated power supply. The voltage range should be within $\pm 10\%$. The switch should be automatic air switch. The setting electric current should be 1.5 times of the running current, and equipped with lack of phase safeguard. The knife switch is forbidden to use in the unit.

The unit must be power on to warm up for at lease 12 hours before running every season. If the cooling only models haven't been working for long term in winter, make sure to discharge out all the water, in case the pipe and the unit are damaged by frost. The master controller and the unit should be in correspondence and couldn't be power off if the heating only models stop working for long term in winter, to avoid the frost damage.

The heat pump switch couldn't be operated frequently, can not be over 4 times within one hour. The electric cabinet shall prevent to be affected with damp.

Forbid to flush the EVI DC inverter air source heat pump with water, avoid any electric shock or other accidents.

Common Faults and Debugging

©The user must hire the professional maintenance staff to fix if the unit has any problems during working. The maintenance staff might refer to the chart to debug.

Error Status	Possible reason	Solution
Heat pump not running	Power fault Wiring loose Fuse blow fused Thermal Overloaded protector off Low pressure too low	Put off the power switch, check the power supply find out the causes and repair Replace the fuse blow test the voltage and current
Water pump is working but without water cycle or water pump high noise	Lack of water in the system with air in the water system the valves are not all open filter is dirty and blocked	Check the system replenishment device and replenish the system discharge the air in the water system Open the water system valve Clean the water filter
Low heating capacity	Lack of refrigerant Bad heat preservation of water system; Dry filter blocked Bad heat dissipation of air heat exchanger Not enough water flow	Leakage detecting and supply refrigerant Reinforce the heat preservation of water system Change the dry filter Clean the air heat exchanger Clean the water filter
Compressor not working	Power failure; Contactor of compressor damage; wiring loose Compressor overheat protection outlet water temp. Too high; Not enough water flow Compressor overload protector tripped	Find out the causes and solve the power failure Change the contactor of compressor Find out the loose point and repair Check the unit pressure and Exhaust gas temp. Reset the outlet water temp Clean the water filter and discharge the air in the system Check the running current and whether overload protector damage
compressor running noise too high	Liquid refrigerant enter the compressor The inner parts of compressor damage Too Low voltage	Check the expansion valve whether out of effect Replace the compressor Check Power Voltage
Fan not working	The fastening screw of the fan loose Fan motor damage Contactor damage	Reinforce the screw Replace the fan motor Replace the contactor
Compressor running but heat pump not heating	Refrigerant is all leaking out Compressor fault Compressor reversal	Check leakage and charging the refrigerant Replace the compressor Exchange the phase order of compressor
Low water flow protection	Not enough water flow in the system Water switch fault	Clean the water filter and discharge the air in the system Check the water switch and replace it

Section 5 WIFI Connection and Operation

APP Download

©Please go to “Google Play Store” or “Apple App Store” and search “Smart Life” or “Tuya Smart” then download. See below figures.

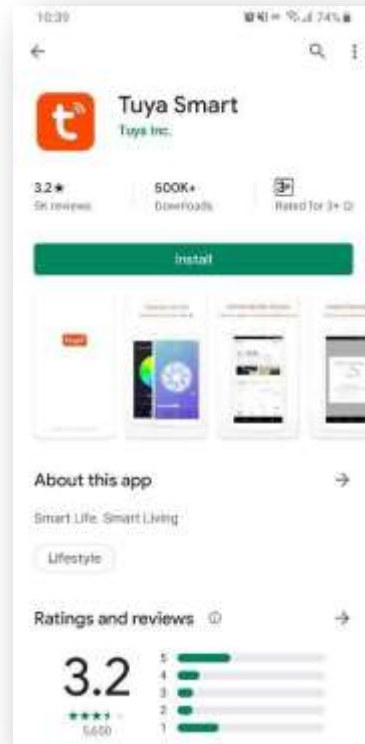

WIFI Connect Method 1: intelligent network distribution mode:

The 1st step:

©By default, it can be connected within 10s after the first power-on, and it needs to be connected by pressing buttons after 10 seconds. (10s is the delay for wifi to enter low power consumption)

©Manually enter the smart distribution mode: select "SMART MODE" on the WIFI interface of the wired controller, click "WIFI RESET" to enter the smart distribution mode, the "📶" icon on the main interface flashes, and the mobile phone can start to configure the network.



©Exit the network configuration status after 3 minutes, the "  " icon stops flashing, and the WIFI module is no longer networked. If you want to configure the network again, you need to click the "WIFI RESET" button on the WIFI interface again.

The 2nd step:

©Turn on the WIFI function of the mobile phone and connect to the WIFI hotspot. The WIFI hotspot must be able to connect to the Internet normally, as shown in the figure: Connect the WIFI hotspot "123456789".



The 3rd step:

© Open the "Smart Life" APP, log in and enter the main interface, click "+" in the upper right corner or "Add Device" on the interface to enter the device type selection, and select "Water Heater" in the "Large Home Appliance" to enter the add device interface.

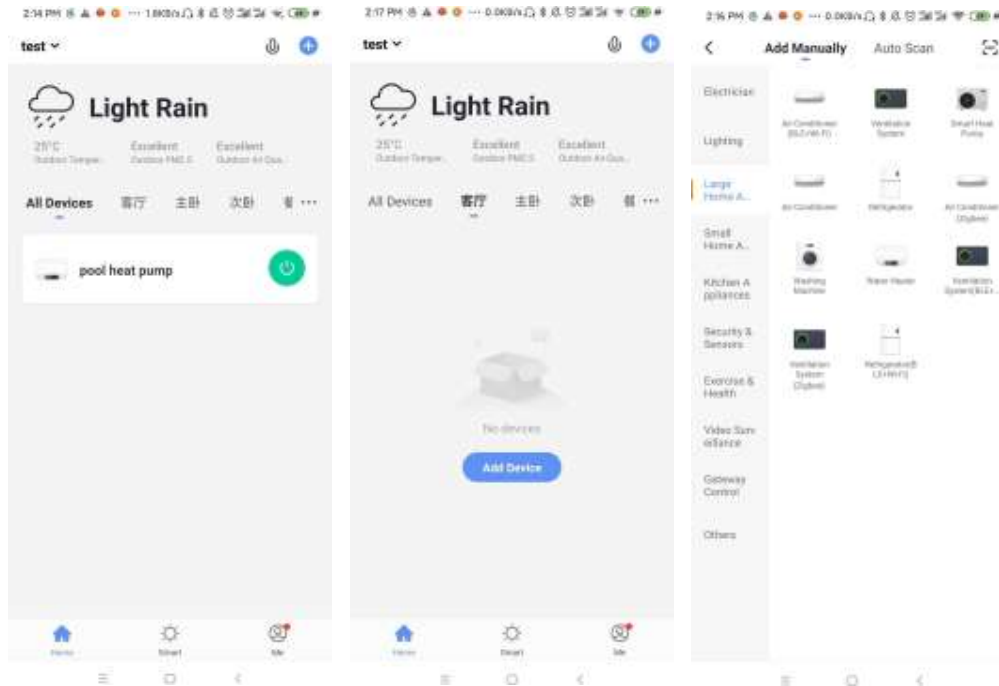

The 4th step:

© After selecting the water heater, enter the "Add Device" interface, confirm that the wired controller has selected the intelligent network distribution mode, and after the "📶" icon is in the fast flashing state, click "Confirm indicator rapidly blink".



© Enter the WIFI connection interface, enter the WIFI password that the mobile phone is connected to (must be the same as the WIFI connected to the mobile phone), and click "Next" to directly enter the device connection state.

Remarks: When the wired controller's WIFI module is connected to the WIFI hotspot, the "📶" icon flashes **fast**.

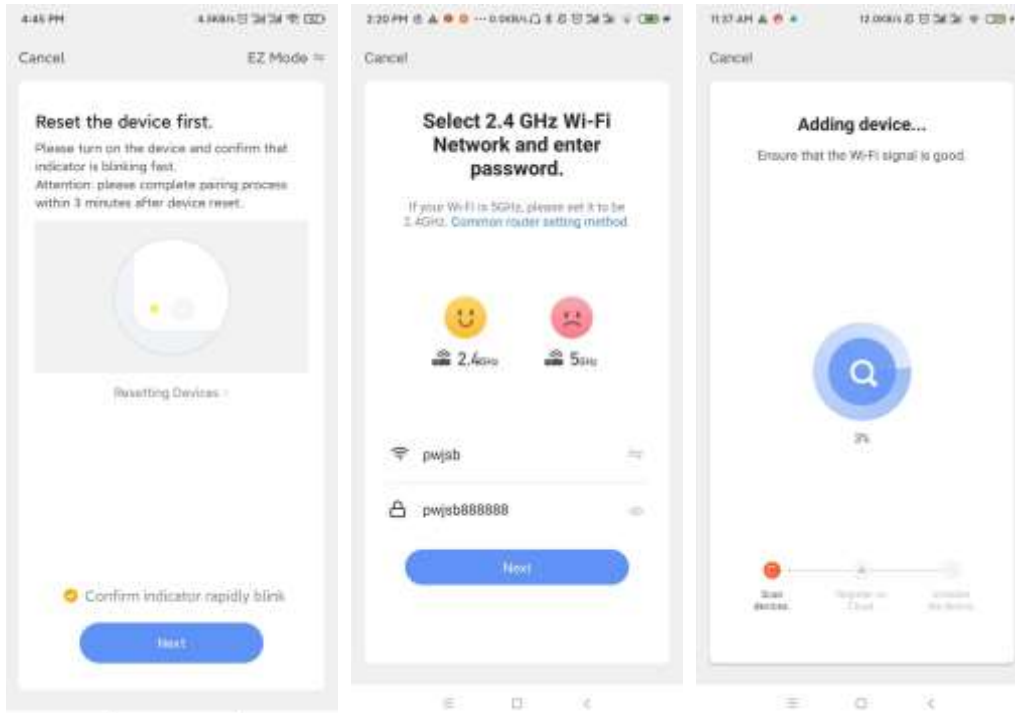

The 5th step:

©When the "Scan devices", "Register on Cloud", and "Initialize the device" are all completed, the connection is successful and the system prompts "Added successfully", then the network configuration is successful. In this interface, you can change the device name at , select the device installation location (living room, master bedroom...), and then click "Done" to directly enter the main interface of the device operation.

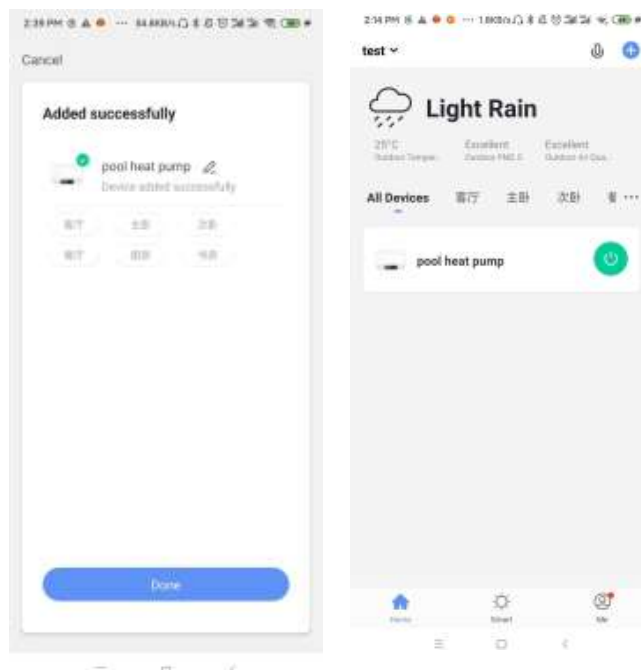

WIFI Connect Method 2: AP distribution network mode:

The 1st step

©Select "AP MODE" on the WIFI interface of the wired controller, click "WIFI RESET" to enter the AP network configuration mode, the "📶" icon on the main interface flashes, and the mobile phone can start network configuration.

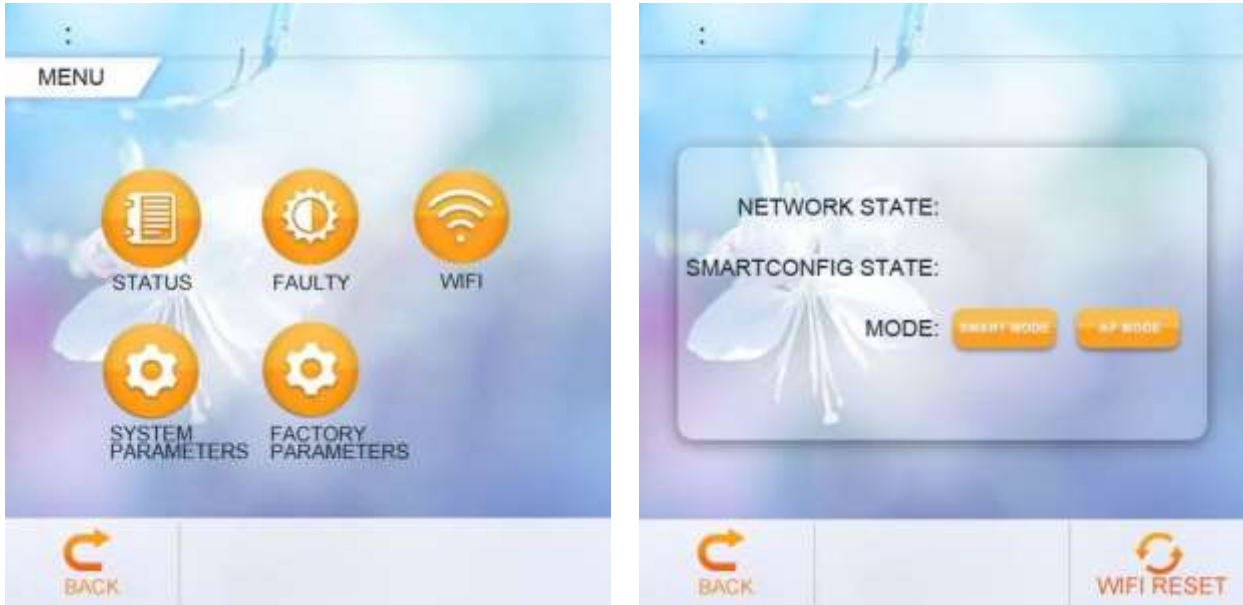

©Exit the network configuration status after 3 minutes, the "📶" icon stops flashing, and the WIFI module is no longer networked. If you want to configure the network again, you need to click the "WIFI RESET" button on the WIFI interface again.

The 2nd step:

©Turn on the WIFI function of the mobile phone and connect to the WIFI hotspot. The WIFI hotspot must be able to connect to the Internet normally, as shown in the figure: Connect the WIFI hotspot "123456789".



The 3rd step

©Open the "Smart Life" APP, log in and enter the main interface, click "+" in the upper right corner or "Add Device" on the interface to enter the device type selection, and select "Water Heater" in the "Large Home Appliance" to enter the add device interface.

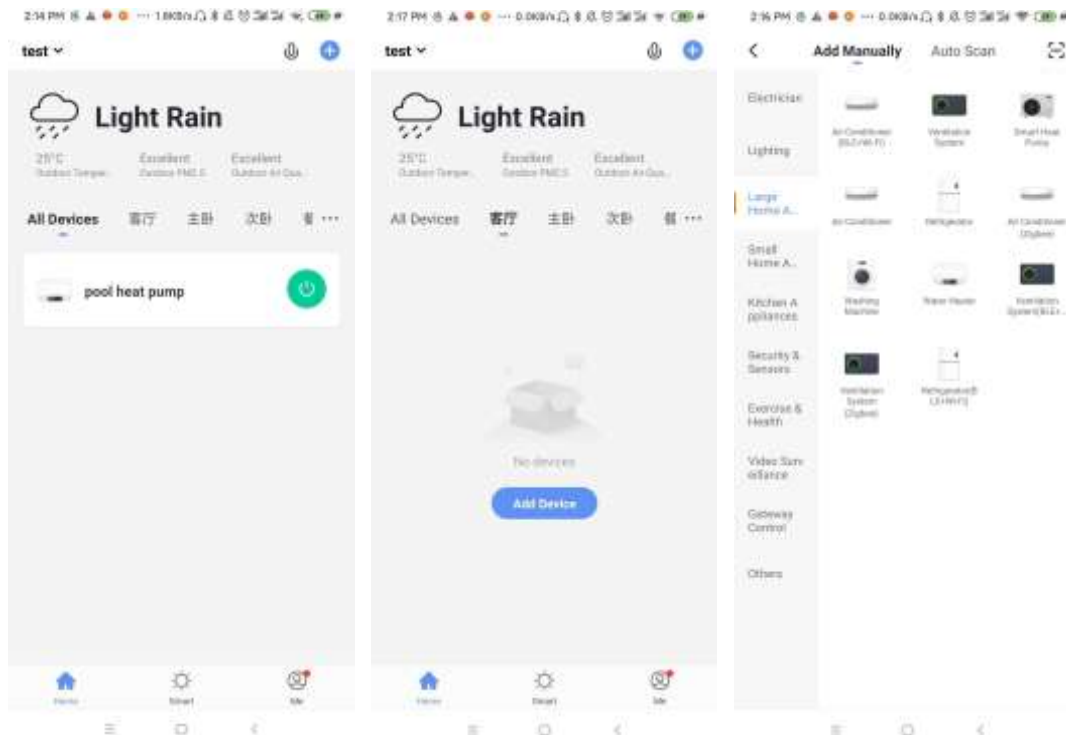

The 4th step:

©After entering the add device interface, click "AP Mode" in the upper right corner, enter the AP mode add device interface, confirm that the AP network configuration mode is selected ("📶" icon flashes), click "Next" and the indicator light flashes slowly.



©Pop up the WIFI connection interface, enter the WIFI password that the mobile phone is connected to (must be the same as the WIFI connected to the mobile phone), click "Next", and the "Connect your mobile phone to the device's hotspot" pops up, follow the prompts, and click "Go to Connect".

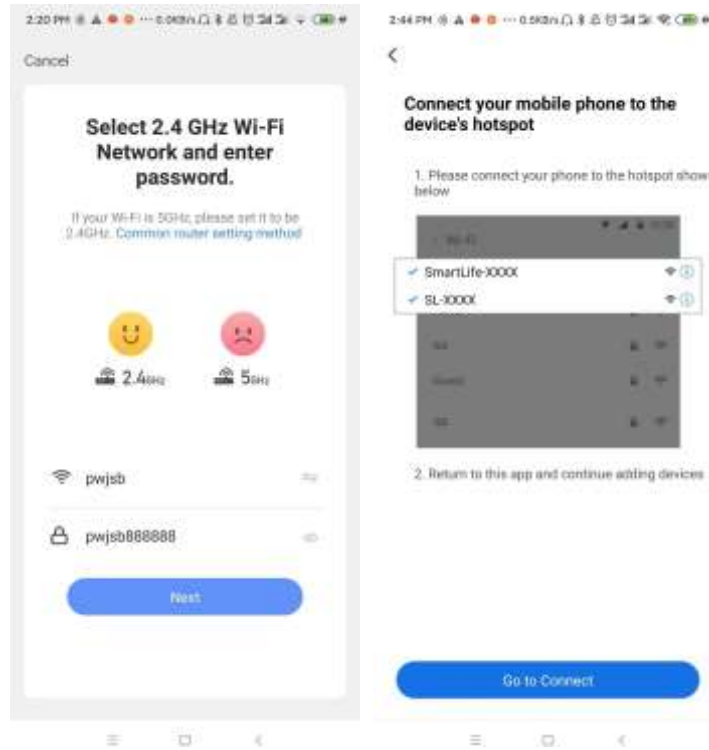

©Enter the mobile phone's WIFI connection interface, find the connection of SmartLife_XXX, as shown in the figure: SmartLife_E4A1, return to the "Smart Life" APP, and the APP will automatically enter the device connection state.

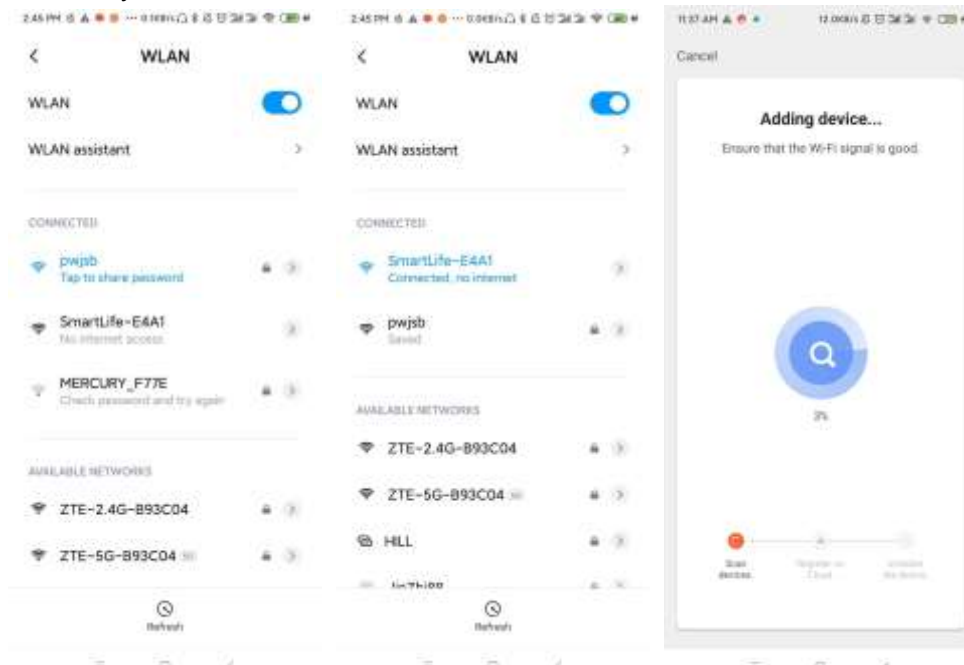

The 5th step:

©When the "Scan devices", "Register on Cloud", and "Initialize the device" are all completed, the connection is successful and the system prompts "Added successfully", then the network configuration is successful. In this interface, you can change the device name at , select the device installation location (living room, master bedroom...), and then click "Done" to directly enter the main interface of the device operation.

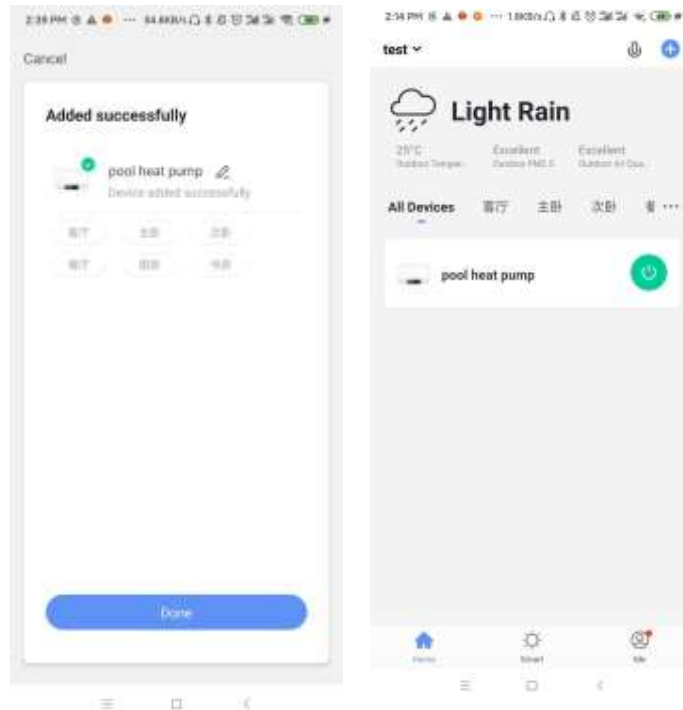

Software function operation

Interface Introduction

- ©After the device is successfully bound, enter the "Heat Pump Controller" (device name can be modified) operation page.
- ©Click "Heat Pump Controller" in "All Devices" in the main interface of "Smart Life" APP to enter the "Heat Pump Controller" device's operation page.

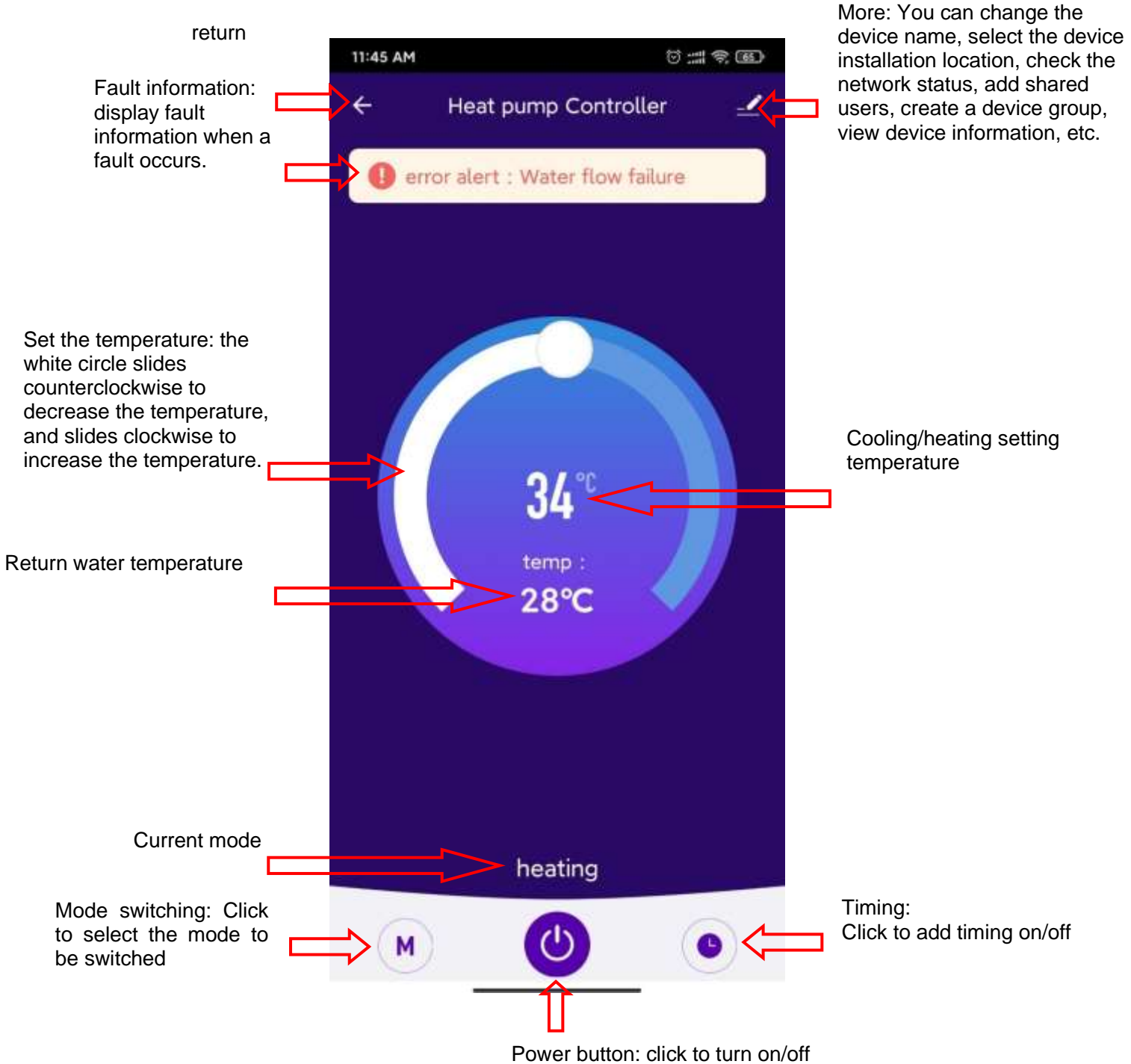

Modify device name

©Click to enter "Device Information" in the sequence as shown below, and click "Name" to rename the device name.

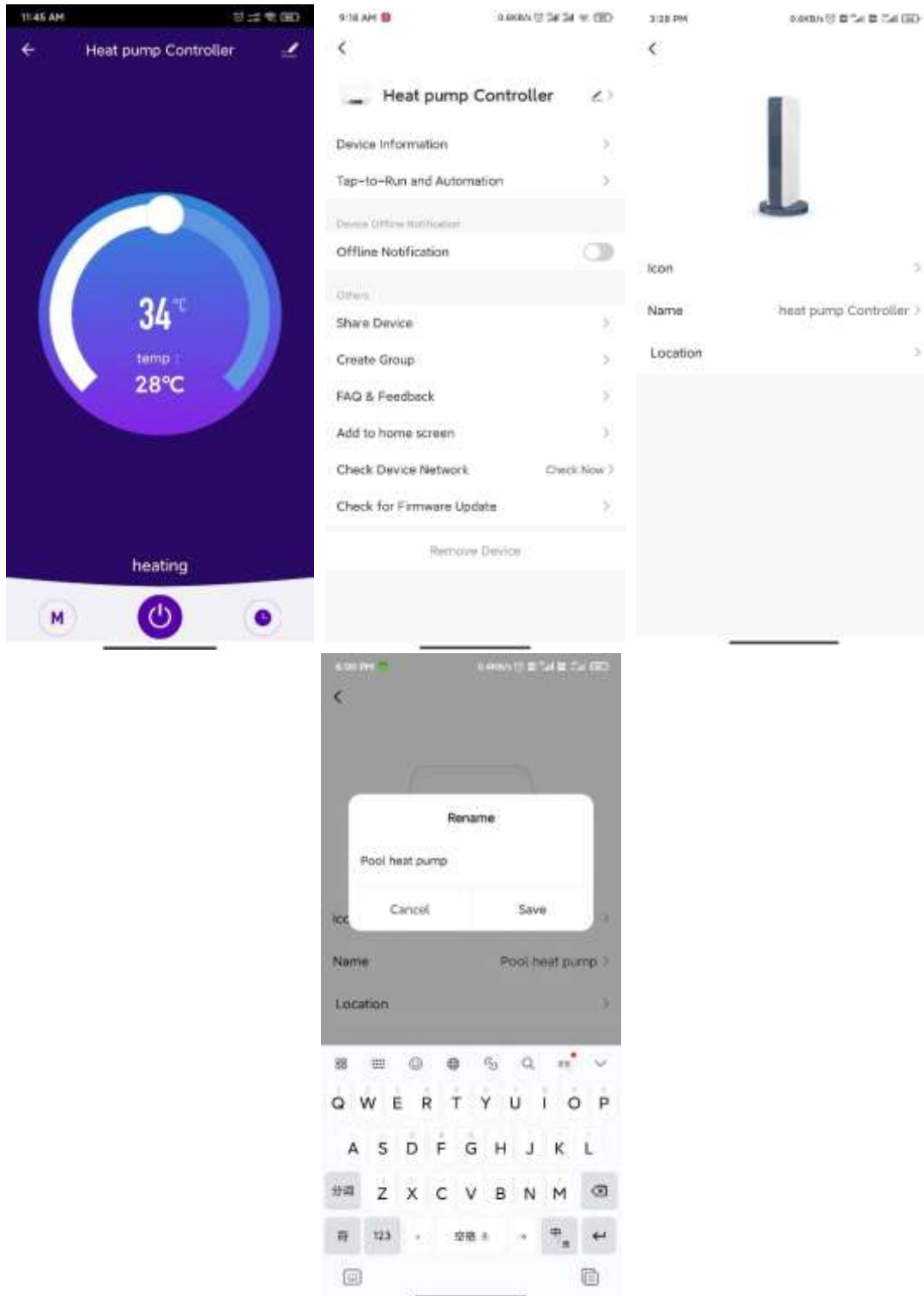

Equipment sharing

- ◎Share the bound device, the sharer operates in the following sequence.
- ◎After successful sharing, the list will be increased and show the shared person.
- ◎To delete the shared person, long press the selected user, the delete interface will pop up, click "**Delete**".
- ◎The operation of the sharing interface is as follows:

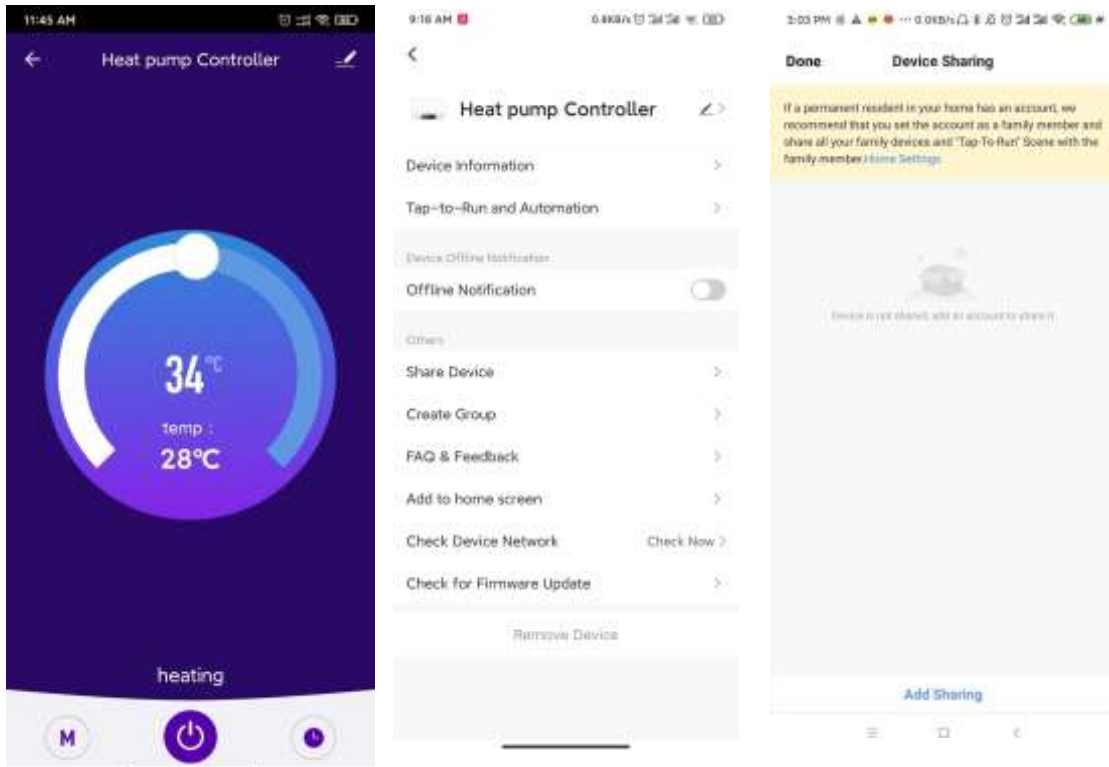

©Input the account of the shared person, click "Done", the shared success list will display the account of the newly-added shared person. The interface of the shared person is as follows, showing the received shared device, click in to operate and control the device.

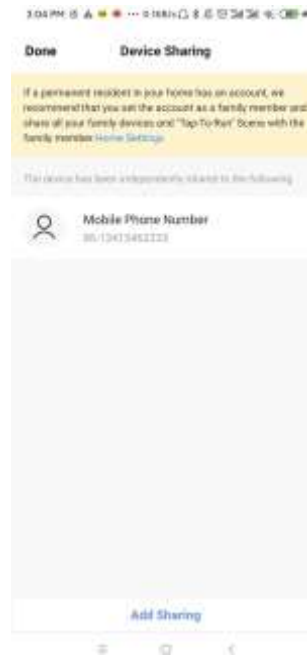

Mode setting

©Click "  " on the main interface of the equipment operation to switch mode, and the mode selection interface will pop up as shown in the figure below, just click the mode you need to select.



Timer setting

©In the main interface, click ”” to enter timer setting, click to add timer.

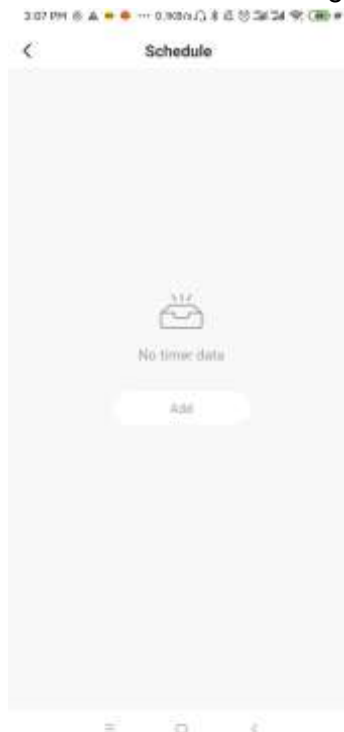

©In the timer setting, slide the hour/minute up and down to set the timer time, and set the repeating week and on/off, press the upper right corner to save, as shown in the below Fig,

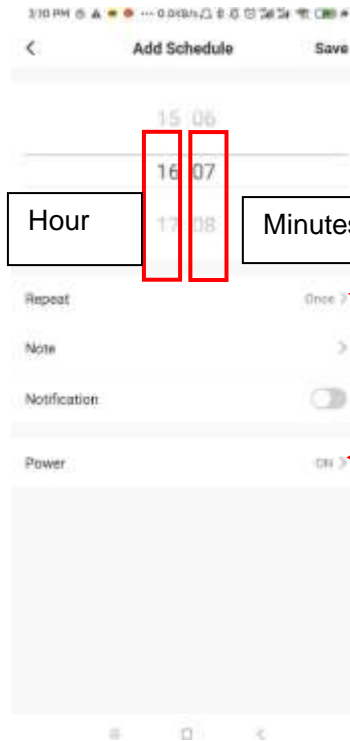



Hour Minutes

Available select repeating times

Available setting timer power on/off

Device removal

©APP removal

Click  in the upper right corner of device operation main interface to enter device details interface, and click "Remove Device" interface to enter the intelligent network configuration mode. "  " Corresponding indicator light does not flash, and the network can be reconfigured within 3 minutes. If it exceeds 3 mins, it will exit the distribution network.

